

F - FONDO CABINA
A - ALTEZZA MONTANTE
H - ALTEZZA CABINA COMPRESO DI FONDO
D - INTERASSE PATTINI
P - PROFONDITA CABINA
L - LARGHEZZA ESTERNA CABINA

ARCATA IDRAULICA IN TAGLIA A 2 PISTONI

PORTATA Q=3500 Kg.

Paracadute istantaneo PI 44

Velocità max 0,63 m/sec

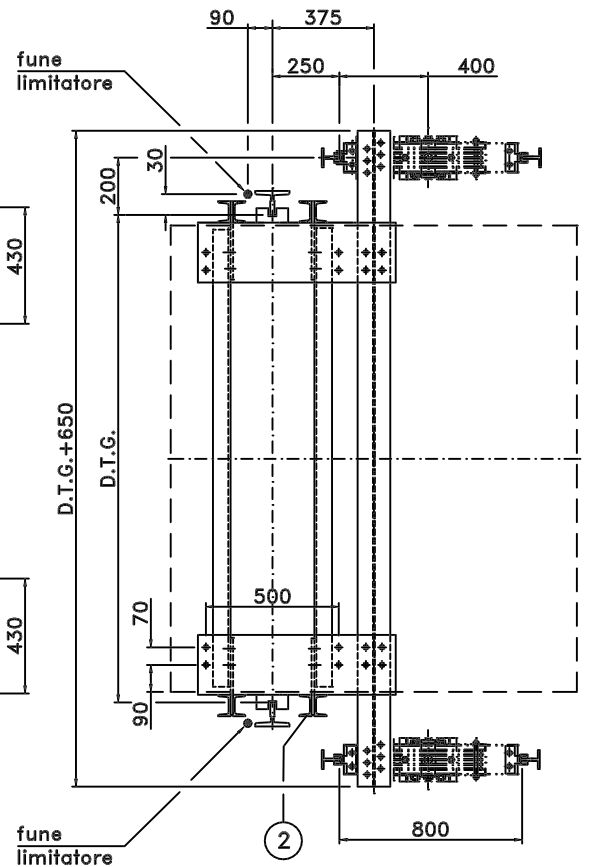
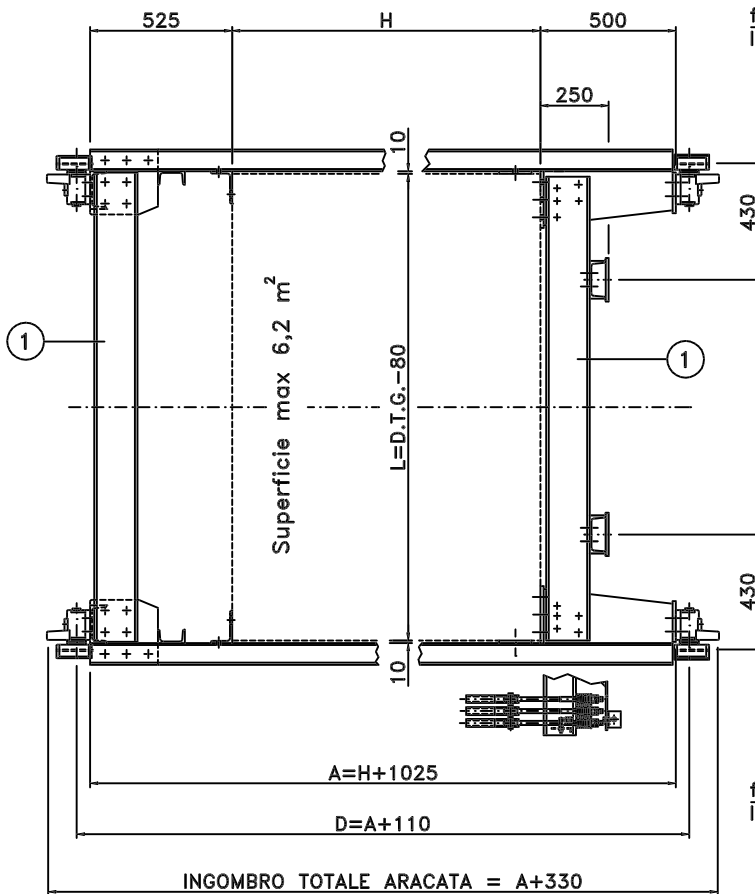
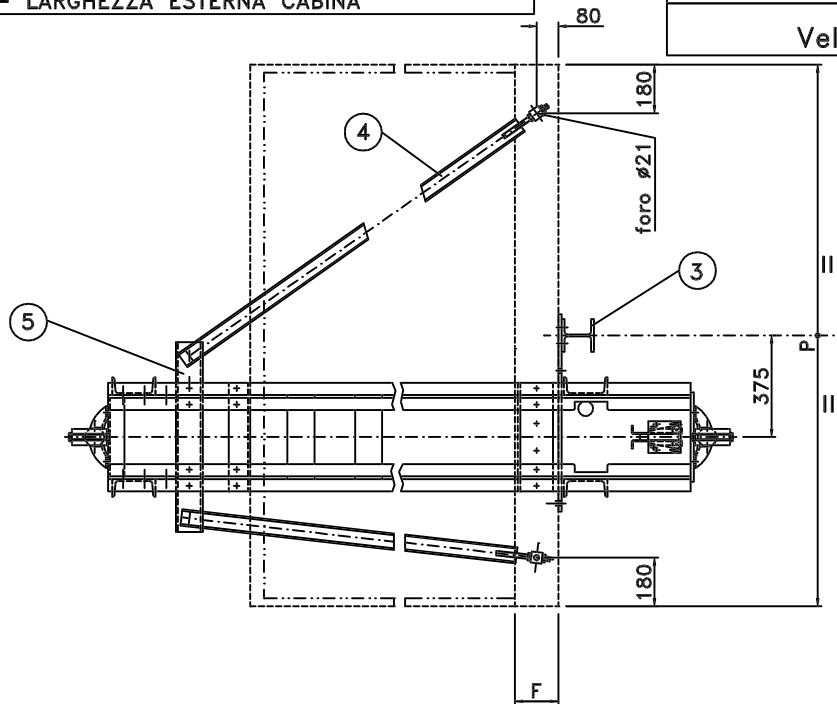

PEZZO	Q.TA'	SEZ. PROFILI
1	04	UNP 160
2	08	UNP 80
3	01	HEB 120
4	04	UNP 60
5	02	UNP 100
6		

